

Dell™ Mobile Projector M115HD

User's Guide



Notes, Cautions, and Warnings



NOTE: A NOTE indicates important information that helps you make better use of your projector.



CAUTION: A CAUTION indicates potential damage to hardware or loss of data if instructions are not followed.



WARNING: A WARNING indicates a potential for property damage, personal injury, or death.

Information in this document is subject to change without notice.
© 2013 Dell Inc. All rights reserved.

Reproduction of these materials in any manner whatsoever without the written permission of Dell Inc. is strictly forbidden.

Trademarks used in this text: Dell and the DELL logo are trademarks of Dell Inc.; DLP and DLP logo and DLP BrilliantColor are trademarks of TEXAS INSTRUMENTS INCORPORATED; Microsoft and Windows are either trademarks or registered trademarks of Microsoft Corporation in the United States and/or other countries.

Wi-Fi® is a registered trademark of Wireless Ethernet Compatibility Alliance, Inc.

Other trademarks and trade names may be used in this document to refer to either the entities claiming the marks and names or their products. Dell Inc. disclaims any proprietary interest in trademarks and trade names other than its own.

Model : Dell Mobile Projector M115HD

August 2013 Rev. A00

Contents

1	Your Dell Projector	4
	About Your Projector	5
2	Connecting Your Projector	7
	Connecting to a Computer	8
	Connecting a DVD Player	12
	Connecting to Multimedia	13
3	Using Your Projector	15
	Turning Your Projector On	15
	Turning Your Projector Off	15
	Adjusting the Projected Image	16
	Adjusting the Projector Focus	17
	Adjusting Projection Image Size	18
	Using the Control Panel	20
	Using the Remote Control	22
	Installing the Remote Control Battery (Optional)	24
	Operating Range with Optional Remote Control	25
	Using the On-Screen Display	26
	Multimedia Introduction	39
4	Troubleshooting Your Projector	50
	Guiding Signals	53
5	Specifications	54
6	Contacting Dell	58
7	Appendix: Glossary	59

1

Your Dell Projector

Your projector comes with all the items shown below. Ensure that you have all the items, and contact Dell™ if anything is missing.

Package Contents

Power cable

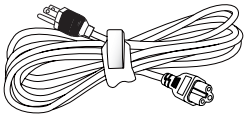

Universal 24-pin to VGA cable

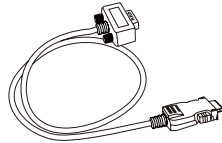

Carrying case

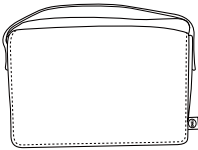

CD User's Guide and Documentation

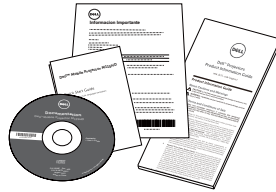

AC adapter

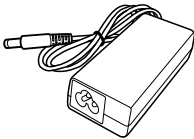

About Your Projector

Top View

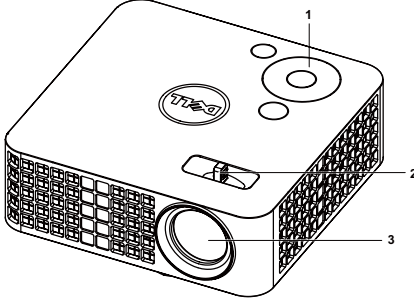

Bottom View

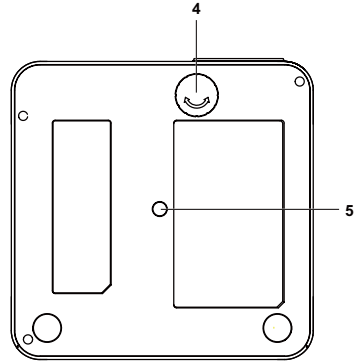

- | | |
|---|--|
| 1 | Control panel |
| 2 | Focus tab |
| 3 | Lens |
| 4 | Tilt adjusting wheel |
| 5 | Mounting hole for tripod: Insert nut 1/4"*20 UNC |

CAUTION: Safety Instructions

- 1 Do not use the projector near appliances that generate a lot of heat.
- 2 Do not use the projector in areas where there is an excessive amount of dust. The dust may cause the system to fail and the projector will automatically shut down.
- 3 Ensure that the projector is mounted in a well-ventilated area.
- 4 Do not block the ventilation slots and openings on the projector.
- 5 Ensure the projector operates between ambient temperatures (5 °C to 35 °C).
- 6 Do not try to touch the ventilation outlet as it can become very hot after the projector has been turned on or immediately after it is turned off.
- 7 Do not look into the lens while the projector is on as it may cause injury to your eyes.
- 8 Do not place any objects near or in front of the projector or cover its lens while the projector is on as the heat may cause the object to melt or burn.

- 9 Do not use alcohol to wipe the lens.
- 10 Do not use the wireless projector near cardiac pacemakers.
- 11 Do not use the wireless projector near medical equipment.
- 12 Do not use the wireless projector near microwave ovens.



NOTE:

- Recommended Projector Kit (P/N: VXJN3). For more information, see the Dell Support website at dell.com/support.
- For more information, see the Safety Information that shipped with your projector.
- The M115HD projector can only be used indoors.

2

Connecting Your Projector

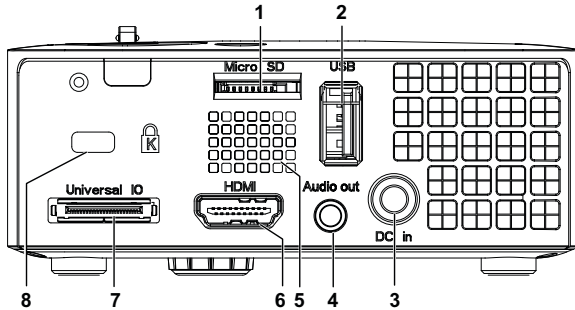

-
- | | | | |
|---|--|---|---------|
| 1 | Micro SD card slot for multimedia playback (Video/Music/Photo/Office Viewer) and supporting media and image processor firmware upgrade | 5 | Speaker |
|---|--|---|---------|
-
- | | | | |
|---|--|---|----------------|
| 2 | USB type A connector for USB display, multimedia playback (Video/Music/Photo/Office Viewer), USB memory storage access (USB flash drive/internal memory), and supporting projector, media, and image processor firmware upgrade, and supporting optional wireless dongle, MobiShow-Pro, and WiFi-Doc | 6 | HDMI connector |
|---|--|---|----------------|
-
- | | | | |
|---|--------------------|---|---|
| 3 | DC input connector | 7 | Universal I/O connector for VGA input and optional Audio output |
|---|--------------------|---|---|
-
- | | | | |
|---|------------------------|---|---------------------|
| 4 | Audio output connector | 8 | Security cable slot |
|---|------------------------|---|---------------------|
-

⚠ CAUTION: Before you begin any of the procedures in this section, follow the Safety Instructions as described on page 5.

Connecting to a Computer

Connecting a Computer Using a VGA Cable

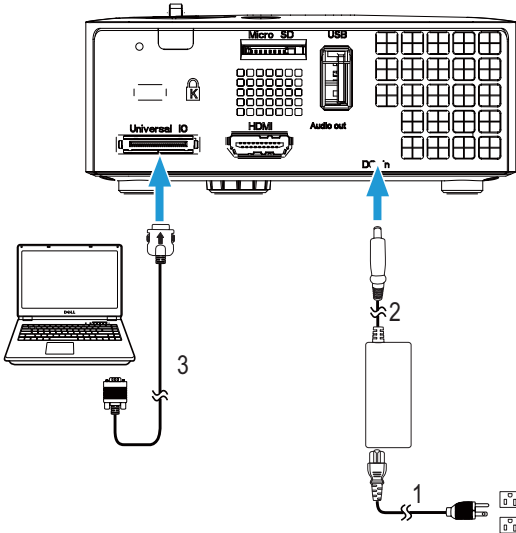

- 1 Power cord
- 2 AC adapter
- 3 Universal 24-pin to VGA cable



NOTE: Only one universal 24-pin to VGA cable is shipped with your projector. An additional universal 24-pin to VGA cable or 24-pin to VGA and Audio out cable can be purchased on the Dell website at www.dell.com.

Connecting a Computer Using a USB Cable

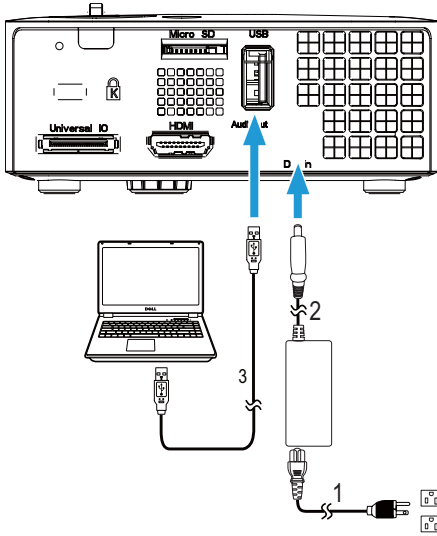



- 1 Power cord
- 2 AC adapter
- 3 USB-A to USB-A cable

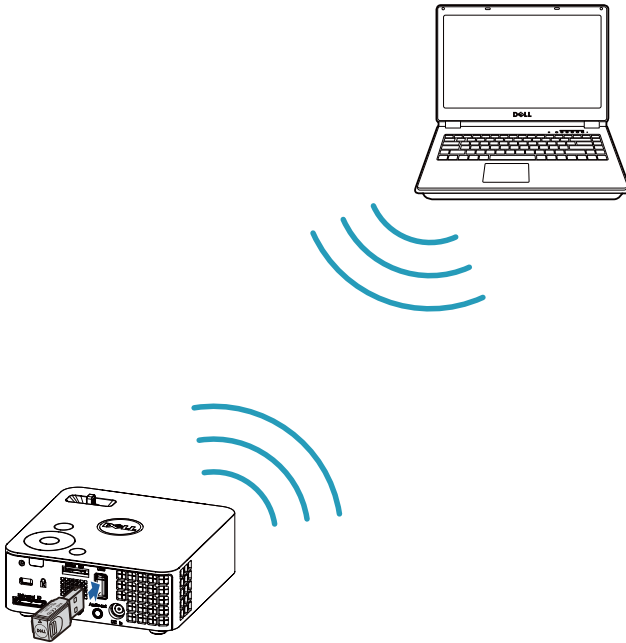

NOTE: Plug and Play. The USB (USB A to A) cable is not shipped with your projector. You can purchase the USB (USB A to A) cable on the Dell website at www.dell.com.

Connecting a Computer Using Wireless Dongle (Optional)



 **NOTE:** Your computer should be equipped with a wireless connector and properly configured to detect another wireless connection. Refer to your computer's documentation on how to configure a wireless connection.

 **NOTE:** Your projector must be installed with a wireless dongle if you want to use the wireless display. The wireless dongle is not shipped with your projector. You can purchase it on the Dell website at www.dell.com.

Connecting to Smartphone or Tablet Using Wireless Dongle (Optional)

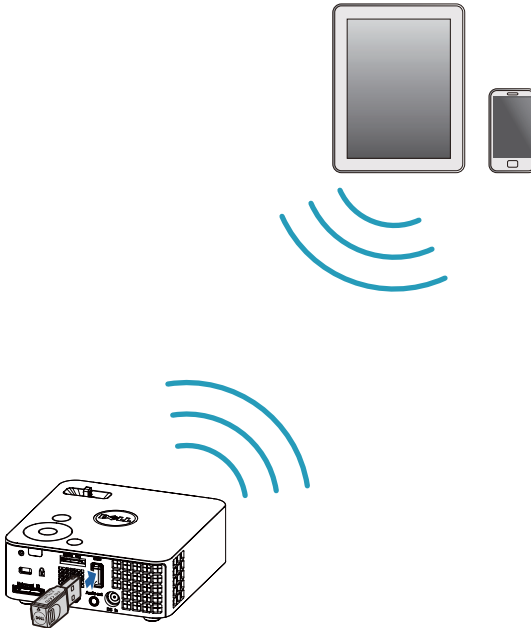

NOTE: Dell M115HD supports MobiShow and WiFi-Doc functions. They are applications which transmit supported content from your Android or iOS devices wirelessly. After installing and launching the application on your mobile device, enable Wi-Fi on your mobile device and connect to the projector network, Dell M115HD. For more Information, please visit the Dell Support site at dell.com/support. Files supported are:

Mobi Show	Photos	jpeg / jpg
	MS Powerpoint	PtG2 (converted from ppt)*
WiFi-Doc	Photos	jpeg / jpg
	MS Powerpoint / Word / Excel / Text / PDF	ppt / pptx / doc / docx / xls / xlsx / txt / pdf

* Please install the PtG2 Converter into your PC for file conversion of ppt into PtG2 format. PtG2 Converter can be downloaded from dell.com/support.

Connecting a DVD Player

Connecting a DVD Player Using a HDMI Cable

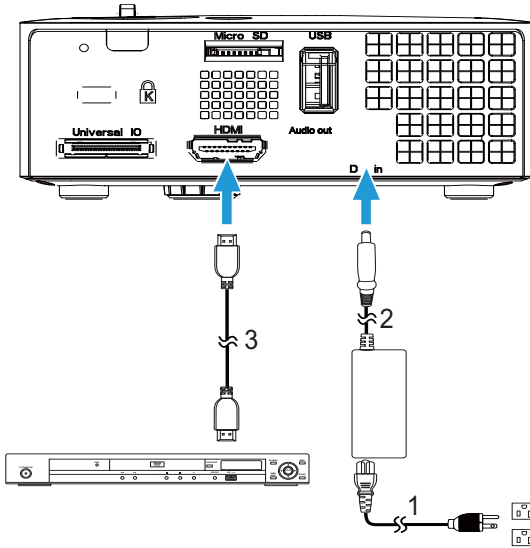

- 1 Power cord
- 2 AC adapter
- 3 HDMI cable



NOTE: The HDMI cable is not shipped with your projector. You can purchase the HDMI cable on the Dell website at www.dell.com.

Connecting to Multimedia

Connecting Multimedia Using a USB Flash Disk

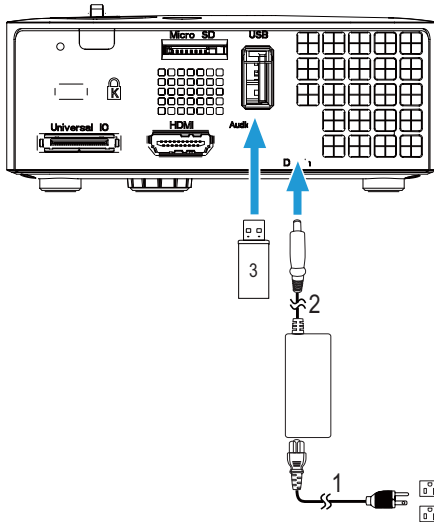

-
- 1 Power cord
 - 2 AC adapter
 - 3 USB flash disk
-



NOTE: The USB flash disk is not shipped with your projector.

Connecting Multimedia Using a Micro SD Card

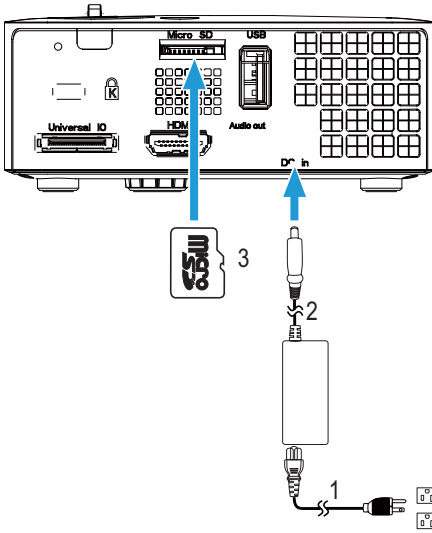

-
- 1 Power cord
 - 2 AC adapter
 - 3 Micro SD card
-

 **NOTE:** The micro SD card is not shipped with your projector.

3

Using Your Projector

Turning Your Projector On



NOTE: Turn on the projector before you turn on the source (computer, DVD player, etc.). The Power button light blinks white until pressed.

- 1 Connect the power cord with AC adapter and appropriate signal cables to the projector. For information about connecting the projector, see "Connecting Your Projector" on page 7.
- 2 Press the **Power** button (see "Using the Control Panel" on page 20 to locate the **Power** button).
- 3 Turn on your source (computer, DVD player, etc.).
- 4 Connect your source to the projector using the appropriate cable. See "Connecting Your Projector" on page 7 for instructions to connect your source to the projector.
- 5 By default, the input source of the projector is set to VGA. Change the input source of the projector if necessary.
- 6 If you have multiple sources connected to the projector, press the Source button on the remote control or control panel to select the desired source. See "Using the Control Panel" on page 20 and "Using the Remote Control" on page 22 to locate the Source button.

Turning Your Projector Off



CAUTION: Unplug the projector after properly shutting down as explained in the following procedure.

- 1 Press the **Power** button. Follow the instruction displayed on screen to properly turn off the projector.



NOTE: The "**Press Power Button to Turn off Projector**" message will appear on the screen. The message disappears after 5 seconds or you can press the Menu button to clear it.

- 2 Press the **Power** button again. The cooling fans continue to operate for 120 seconds.
- 3 To power off the projector quickly, press the Power button and hold for 1 second while the projector's cooling fans are still running.

 **NOTE:** Before you turn on the projector again, wait for 60 seconds to allow the internal temperature to stabilize.

4 Disconnect the power cord and AC adapter from the electrical outlet and the projector.

Adjusting the Projected Image

Raising the Projector Height

1 Raise the projector to the desired display angle, and use the front tilt adjustment wheel to fine-tune the display angle.

Lowering the Projector Height

1 Lower the projector, and use the front tilt adjustment wheel to fine-tune the display angle.

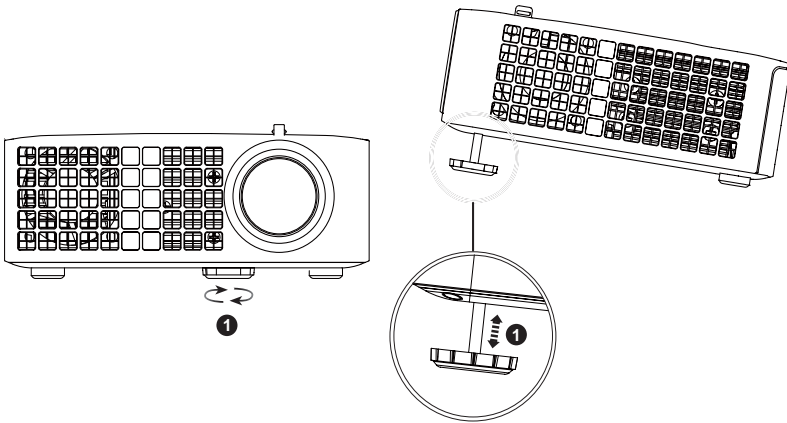

1 Front tilt adjustment wheel
(Angle of tilt: 0 to 6 degrees)

Adjusting the Projector Focus

⚠ CAUTION: To avoid damaging the projector, ensure that the front adjustment wheel is fully retracted before moving the projector or placing the projector in its carrying case.

1 Rotate the focus tab until the image is clear. The projector focuses at distances ranging between 3.18 ft to 8.48 ft (97 cm to 258 cm).

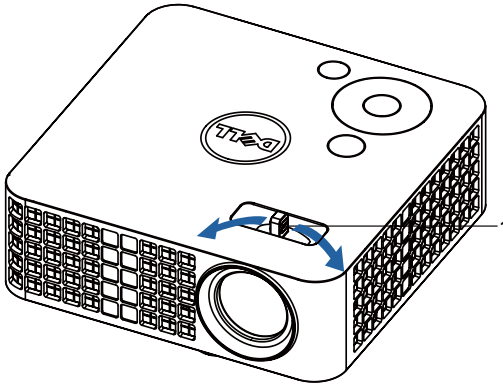

1 Focus tab

Adjusting Projection Image Size

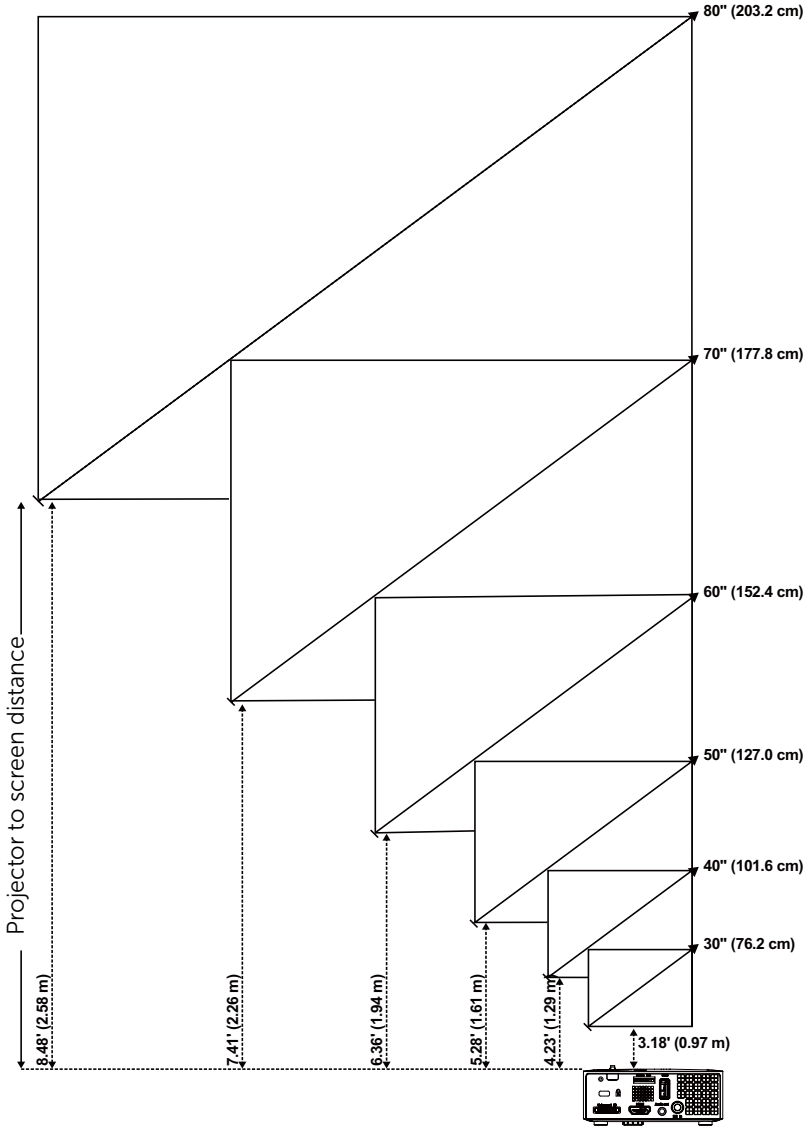

Desired Distance (m) <A>	Screen size		Height
	Diagonal (inch) 	W (cm) x H (cm)	From base to top of image (cm) <C>
0.97	30	65 x 40	40
1.29	40	86 x 54	54
1.61	50	107 x 67	67
1.94	60	129 x 81	81
2.26	70	151 x 94	94
2.58	80	171 x 108	108



* This graph is for user reference only.

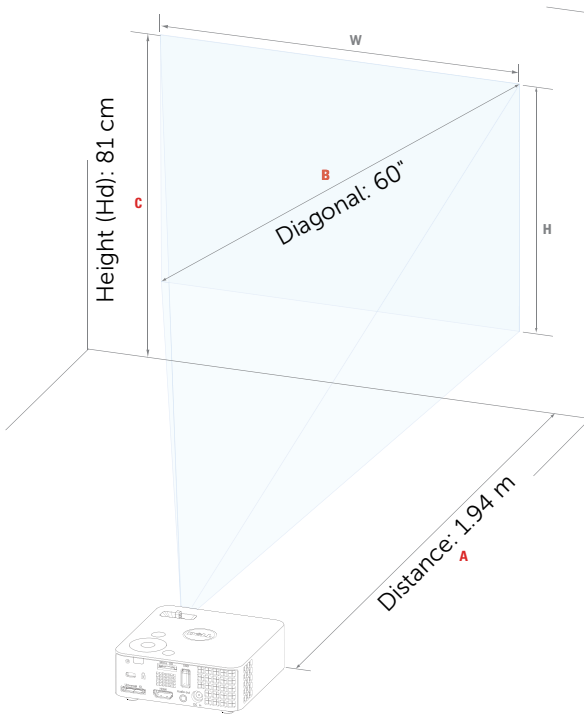

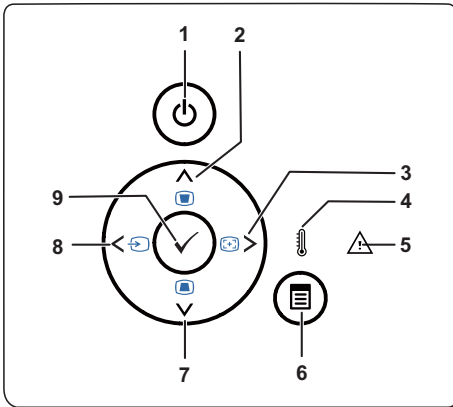

* Offset Ratio: 100 %



Using the Control Panel









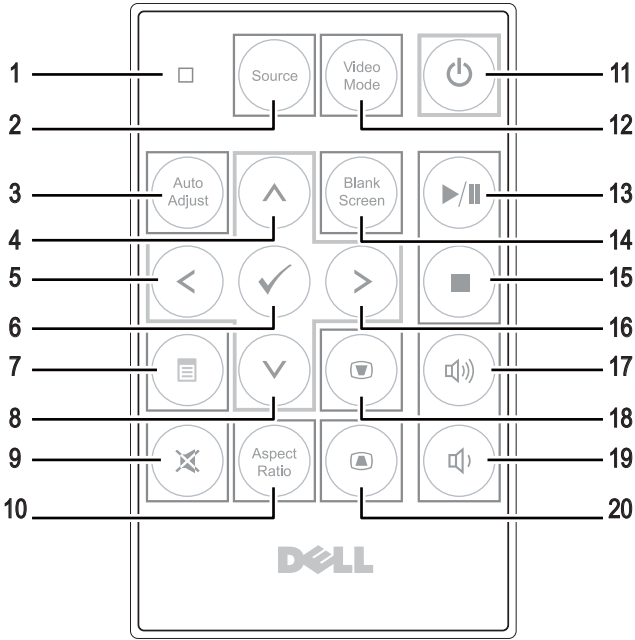

- | | |
|--|--|
| 1 Power | Turns the projector on or off. For more information, see "Turning Your Projector On" on page 15 and "Turning Your Projector Off" on page 15. |
| 2 Up  / Keystone adjustment | Press to navigate through the On-Screen Display (OSD) Menu items.
Press to adjust image distortion caused by tilting the projector (+/-40 degrees). |
| 3 Right  / Auto Adjust | Press to navigate through the On-Screen Display (OSD) Menu items.
Press to synchronize the projector to the input source. |
| |  NOTE: Auto Adjust does not operate if the on-screen display (OSD) is displayed. |
| 4 TEMP LED | If the TEMP amber indicator is on or blinking, one of the following problems could be occurring: <ul style="list-style-type: none"> • Internal temperature of the projector is too high For more information, see "Troubleshooting Your Projector" on page 50 and "Guiding Signals" on page 53. |

5	Error LED	Error LED is blinking amber, one of the fans has failed. The projector will automatically shut down.
6	Menu 	Press to activate the OSD. Use the directional keys and the Menu button to navigate through the OSD.
7	Down  / Keystone adjustment	Press to navigate through the On-Screen Display (OSD) Menu items. Press to adjust image distortion caused by tilting the projector (+/-40 degrees).
8	Left  / Source	Press to navigate through the On-Screen Display (OSD) Menu items. Press to toggle through VGA, DoUSB, HDMI, USB, MicroSD, and Internal Memory sources when multiple sources are connected to the projector.
9	Enter 	Press to confirm the selection item.

Using the Remote Control



1	LED light	LED indicator.
2	Source	Press to switch between VGA, DoUSB, HDMI, USB, MicroSD, and Internal Memory source.
3	Auto adjust	Press to synchronize the projector with the input source. Auto adjust does not operate if the OSD (On-Screen Display) is displayed.
4	Up (▲)	Press to navigate through the On-Screen Display (OSD) Menu items.
5	Left (◀)	Press to navigate through the On-Screen Display (OSD) Menu items.
6	Enter (✓)	Press to confirm the selection.
7	Menu (☰)	Press to activate the OSD.
8	Down (▼)	Press to navigate through the On-Screen Display (OSD) Menu items.

9	Mute 	Press to mute or un-mute the projector speaker.
10	Aspect ratio	Press to change aspect ratio of a displayed image.
11	Power 	Turns the projector on and off. For more information, see "Turning Your Projector On" on page 15 and "Turning Your Projector Off" on page 15.
12	Video mode	<p>The projector has preset configurations that are optimized for displaying data (presentation slides) or video (movies, games, etc.).</p> <p>Press the Video Mode button to toggle between Presentation mode, Bright mode, Movie mode, sRGB, or Custom mode.</p> <p>Pressing the Video Mode button once will show the current display mode. Pressing the Video Mode button again will switch between modes.</p>
13	Play/Pause 	Press to play/pause media file.
14	Blank screen	Press to hide/unhide the image.
15	Stop 	Press to stop playing media file.
16	Right 	Press to navigate through the On-Screen Display (OSD) Menu items.
17	Volume up 	Press to increase the volume.
18	Keystone adjustment 	Press to adjust image distortion caused by tilting the projector (+/-40 degrees).
19	Volume down 	Press to decrease the volume.
20	Keystone adjustment 	Press to adjust image distortion caused by tilting the projector (+/-40 degrees).

Installing the Remote Control Battery (Optional)

- 1 Remove the battery holder by holding down the side release firmly and pulling out the battery holder.

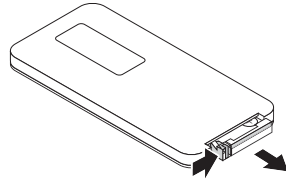

- 2 Insert a CR2032 coin cell battery and align the polarity correctly according to the marking in the battery holder.

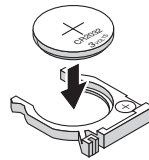

-  **NOTE:** When you use the remote control for the first time, there is a plastic sheet between the battery and its contact. Remove the sheet before use.

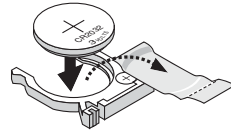

- 3 Replace the battery holder.

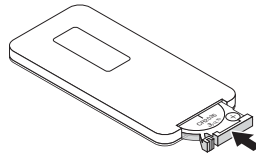



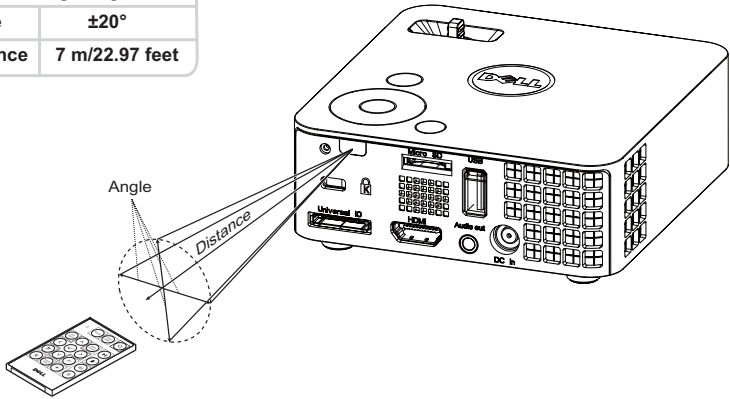

Operating Range with Optional Remote Control

Operating range	
Angle	$\pm 20^\circ$
Distance	7 m/22.97 feet



NOTE: Actual operating range may slightly differ from the diagram. Weak battery will also prevent the remote control from properly operating the projector.

Using the On-Screen Display

- The projector has a multi-language On-Screen Display (OSD) Menu that can be displayed with or without an input source.
- Press the Menu button on the control panel or the remote control to enter the Main Menu.
- To select an option, press the  or  buttons on your projector's control panel or remote control.
- Use the  or  buttons on the control panel or remote control to adjust the settings.
- To exit the OSD, press the **Menu** button directly on the control panel or the remote control.

INPUT SOURCE

The Input Source menu allows you to select your projector's input source.

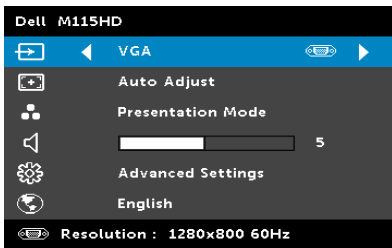

AUTO SOURCE—If you select and press  to activate, the Auto Source option will automatically find the next available input source.

VGA—Press  to detect a VGA signal.

DoUSB—Allows you to display the computer/laptop screen to your projector via the USB cable.



NOTE: If the DoUSB can not display, please see "Troubleshooting" on page 50.

HDMI—Press  to detect a HDMI signal.

USB—Allows you to playback the photo, music, or video files from your USB flash disk. See "Multimedia Introduction" on page 39.

MICRO SD—Allows you to playback the photo, music, or video files from your micro SD card. See "Multimedia Introduction" on page 39.

INTERNAL MEMORY—Allows you to playback the photo, music, or video files from internal memory of the projector. See "Multimedia Introduction" on page 39.



NOTE:

STORAGE MODE—You may also connect USB cable in Internal Memory source to execute copy, delete, move and more instructions from your computer to projector internal memory and SD card.

When you connect the projector and computer via USB cable, a USB Connected message will pop up and allow you to select **DoUSB** or **Storage Mode**.

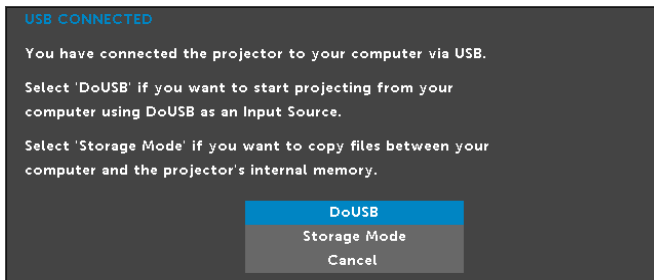

AUTO ADJUST

Auto Adjust automatically adjusts the projector's **Horizontal**, **Vertical**, **Frequency**, and **Tracking** in PC mode.

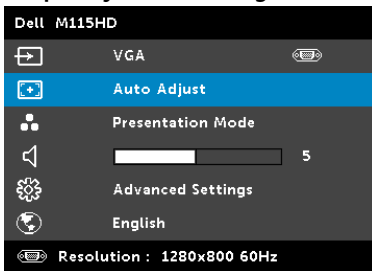

VIDEO MODE

The Video Mode menu allows you to optimize the display image. The options are: **Presentation**, **Bright**, **Movie**, **sRGB** (provides more accurate

color representation), and **Custom** (set your preferred settings) mode.

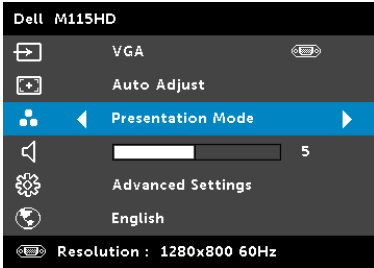

VOLUME

The Volume menu allows you adjust the volume setting of your projector.

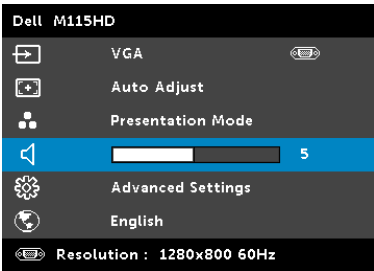

VOLUME—Press \leftarrow to decrease the volume and \rightarrow to increase the volume.

ADVANCED SETTINGS

The Advanced Settings menu allows you to change settings for **Image**, **Display**, **Projector**, **Menu**, **Power**, and **Information**.

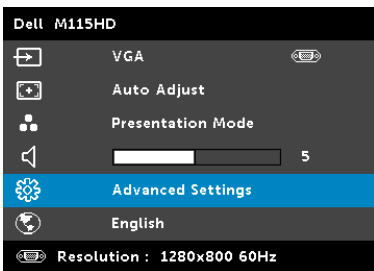

IMAGE SETTINGS (IN PC MODE)—Select and press \checkmark to activate image

settings. The image settings menu provides the following options:



BRIGHTNESS—Press \uparrow and \downarrow to adjust the brightness of the image.

CONTRAST—Press \uparrow and \downarrow to adjust the display contrast.

COLOR TEMPERATURE—Allows you to adjust the color temperature. The screen appears cooler at higher color temperatures and warmer at lower color temperatures.

WHITE INTENSITY—Press \checkmark and use \uparrow and \downarrow to display white intensity.

 **NOTE:** If you adjust the settings for **Brightness, Contrast, Color Temperature, and White Intensity** the projector automatically switches to Custom mode.

IMAGE SETTINGS (IN VIDEO MODE)—Select and press \checkmark to activate image settings. The image settings menu provides the following options:



BRIGHTNESS—Press \uparrow and \downarrow to adjust the brightness of the image.

CONTRAST—Press \uparrow and \downarrow to adjust the display contrast.

COLOR TEMPERATURE—Allows you to adjust the color temperature. The screen appears cooler at higher color temperatures and warmer at lower color temperatures.

SATURATION—Allows you to adjust the video source from black and white to fully saturated color. Press \uparrow to increase the amount of color in the image and \downarrow to decrease the amount of color in the image.

SHARPNESS—Press \uparrow to increase the sharpness and \downarrow to decrease the sharpness.

TINT—Press \uparrow to increase the amount of green in the image and \downarrow to decrease the amount of green in the image.

WHITE INTENSITY—Press \checkmark and use \uparrow and \downarrow to display white intensity.



NOTE: If you adjust the settings for **Brightness, Contrast, Color Temperature, and White Intensity** the projector automatically switches to Custom mode.

DISPLAY SETTINGS (IN PC MODE)—Select and press \checkmark to activate display settings. The display settings menu provides the following options:

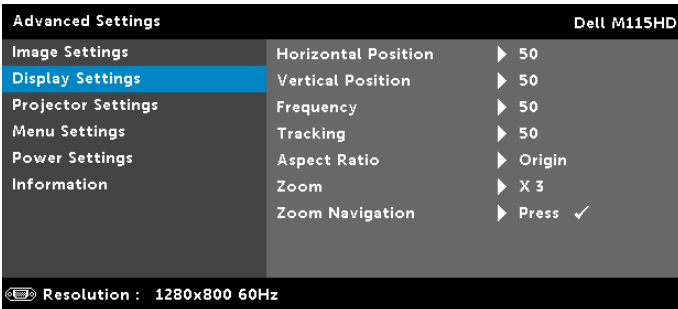

HORIZONTAL POSITION—Press \uparrow to move the image right and \downarrow to move the image left.



VERTICAL POSITION—Press \uparrow to move the image up and \downarrow to move the image down.

FREQUENCY—Allows you to change the display data clock frequency to match the frequency of your computer's graphics card. If you see a vertical flickering wave, use the Frequency control to minimize the bars. This is a coarse adjustment.

TRACKING—Synchronize the phase of the display signal with the graphic card. If you experience an unstable or flickering image, use the Tracking to correct it. This is a fine adjustment.





ASPECT RATIO—Allows you to select the aspect ratio to adjust how the image appears. Options are: Origin, 16:10, and 4:3.

- Origin — Select Origin to maintain the aspect ratio of the image projector according to the input source.
- 16:10 — The input source scales to fit the width of the screen to project a 16:10 screen image.
- 4:3 — The input source scales to fit the screen and projects a 4:3 image.

ZOOM—Press  and  to zoom and view the image.



ZOOM NAVIGATION—Press  to activate the **Zoom Navigation** menu.

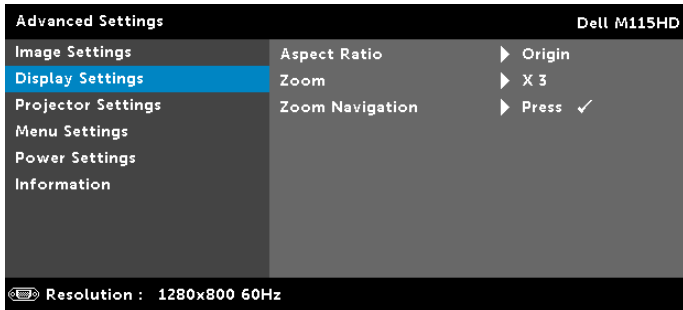

Use     to navigate the projection screen.

DISPLAY SETTINGS (IN VIDEO MODE)—Select and press  to activate display settings. The display settings menu provides the following options:







ASPECT RATIO—Allows you to select the aspect ratio to adjust how the image appears. Options are: Origin, 16:10, and 4:3.

- Origin — Select Origin to maintain the aspect ratio of the image projector according to the input source.
- 16:10 — The input source scales to fit the width of the screen to project a 16:10 screen image.
- 4:3 — The input source scales to fit the screen and projects a 4:3 image.

ZOOM—Press  and  to zoom and view the image.



ZOOM NAVIGATION—Press  to activate the Zoom Navigation menu.

Use     to navigate the projection screen.



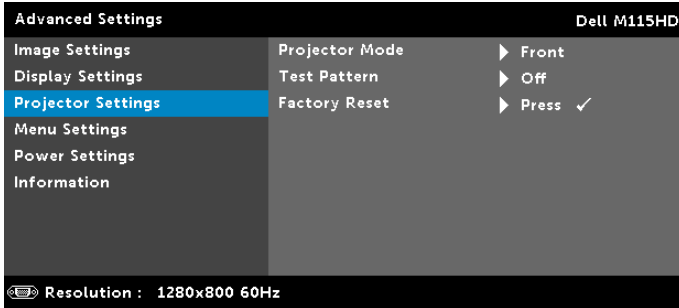

PROJECTOR SETTINGS—Select and press  to activate projector settings. The projector settings menu provides the following options:



PROJECTOR MODE—Allows you to select the projector mode, depending upon how the projector is mounted.

- Rear Projection-Desktop — The projector reverses the image so that you can project from behind a translucent screen.
- Front Projection-Desktop — This is the default option.

TEST PATTERN—Test Pattern is used to test focus and resolution.

You can enable or disable the **Test Pattern** by selecting **Off, 1**, or **2**. You can also invoke the **Test Pattern 1** by pressing and holding down  and  buttons on the control panel simultaneously for 2 seconds. You can also invoke the test pattern 2 by pressing and holding down  and  buttons on the control panel simultaneously for 2 seconds.

Test Pattern 1:

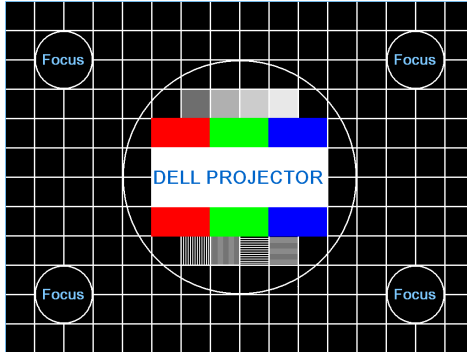

Test Pattern 2:



FACTORY RESET—Select Confirm and press to reset all settings to its factory default. The below warning message appears:



Reset items include both computer sources and Video source settings.

MENU SETTINGS—Select and press to activate the menu settings. The menu settings consists of the following options:

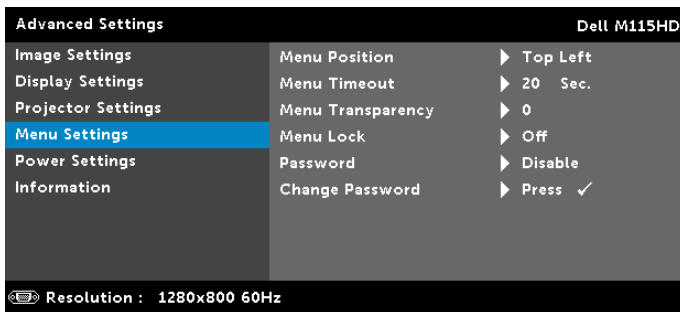

MENU POSITION—Allows you to change the position of the OSD menu on the screen.

MENU TIMEOUT—Allows you to adjust the time for an OSD timeout. By default, the OSD disappears after 20 seconds of non-activity.

MENU TRANSPARENCY—Select to change the transparency level of the OSD background.

MENU LOCK—Select **On** to enable Menu Lock and hide the OSD menu. Select **Off** to disable the Menu Lock. If you want to disable the Menu Lock function and have the OSD disappear, press the Menu button on the control panel or remote control for 15 seconds, then disable the function.

PASSWORD—When Password Protect is enabled, a Password Protect screen requesting you to enter a password will be displayed when the power plug is inserted into the electrical outlet and the power for the projector is first turned on. By default, this function is disabled. You can enable this feature by selecting Enable. If the password has been set before, key in the password first and select the function. This password security feature will be activated the next time you turn on the projector. If you enable this feature, you will be asked to enter the projector's password after you turn on the projector:

1 First time password input request:

- a** Go to **Menu Settings**, press  and then select **Password** to enable the password settings.

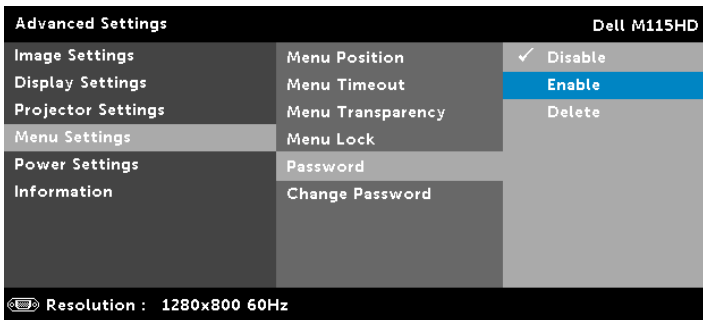

- b Enabling the Password function will pop up a change screen. Key in a 4-digit number from the screen and press .



- c To confirm, enter the password again.
- d If the password verification is successful, you may resume with accessing the projector's functions and its utilities.
- 2 If you have entered an incorrect password, you will be given two more chances. After three invalid attempts, the projector will automatically turn off.



NOTE: If you forget your password, contact DELL or a qualified service person.

- 3 To disable the password function, select the **Disable** option to close the function.
- 4 To delete the password, select the **Delete** option.

CHANGE PASSWORD—Key in the original password. Then, enter the new password and confirm the new password again.

Please key in the original password.

Password (4 character code):

A	B	C	D	E	F	G	H	I	J
K	L	M	N	O	P	Q	R	S	T
U	V	W	X	Y	Z	0	1	2	3
4	5	6	7	8	9	←	Enter	Exit	

PPID CN-0T75G7-50081-31B-0001 Confirm

Please key in new password.

Password (4 character code):

A	B	C	D	E	F	G	H	I	J
K	L	M	N	O	P	Q	R	S	T
U	V	W	X	Y	Z	0	1	2	3
4	5	6	7	8	9	←	Enter	Exit	

PPID CN-0T75G7-50081-31B-0001 Confirm

Please key in new password again.

Password (4 character code):

A	B	C	D	E	F	G	H	I	J
K	L	M	N	O	P	Q	R	S	T
U	V	W	X	Y	Z	0	1	2	3
4	5	6	7	8	9	←	Enter	Exit	

PPID CN-0T75G7-50081-31B-0001 Confirm

POWER SETTINGS—Select and press  to activate power settings. The power settings menu provides the following options:

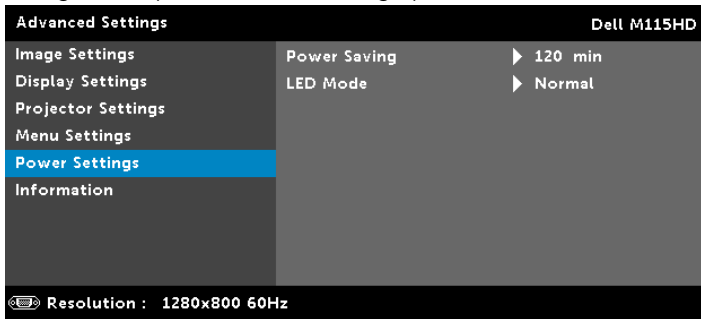

POWER SAVING—By default, the projector is set to enter power saving mode after 120 minutes of no activity. A warning message appears on screen showing a 60 seconds countdown before switching to power saving mode. Press any button during the countdown period to stop the power-saving mode. You can also set a different delay period to enter power saving mode. The delay period is the time you want the projector to wait without an input signal.

If an input signal is not detected during the delay period, the projector turns off. To turn on the projector, press the Power button.

LED MODE—Allows you to select between **Normal** or **ECO** mode. Normal mode operates at full power level. ECO mode operates at a lower power level which may provide longer LED life, quieter operation, and dimmer luminance output on the screen.

INFORMATION—The information menu displays the current M115HD projector settings.

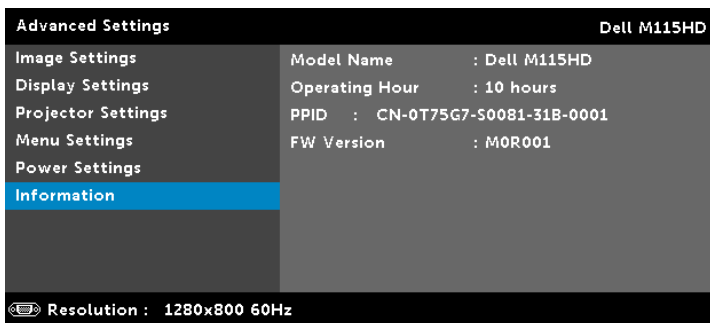

LANGUAGE

Allows you to set the language for the OSD. Press ◀ and ▶ to select different languages and press ✓ to change the language.

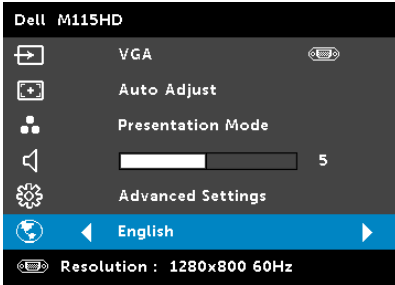

Multimedia Introduction

Multimedia format supported:

Photo Format

Image Type (Ext Name)	Sub Type	Encode Type	Max Pixels	Max Size
Jpeg / Jpg	Baseline	YUV420	No Limitation	2GB
		YUV422		
		YUV440		
		YUV444		
	progressive	YUV420	64x panel resolution	2GB
		YUV422		
		YUV440		
		YUV444		
BMP			64x panel resolution	

Video Format

File Format	Video Format	MAX Res	MAX Bit Rate (bps)	Audio Format
MOV, MP4, AVI, MKV, DIVX	H264	1080P	20Mbps	AC3, DTS, MP1, MP2, MP3, PCM, ADPCM
MOV, MP4	MPEG4	1080P	20Mbps	AMR, PCM, ADPCM
WMV	WMV3	1080P	20Mbps	WMA2, WMA3

Music Format

Music Type (Ext Name)	Sample Rate (KHz)	Bit Rate (Kbps)
MP1	8-48	8-320
MP2	8-48	8-320
MP3	8-48	8-320
WMA	22-48	5-320

How to set-up File Type for Multimedia with USB

 **NOTE:** A USB flash disk must be plugged into the projector if you want to use the multimedia USB function.

Follow these steps to playback the Photo, Video, or Music files on your projector:

- 1 Connect the power cable with AC adapter and turn on the projector by pressing the power button.

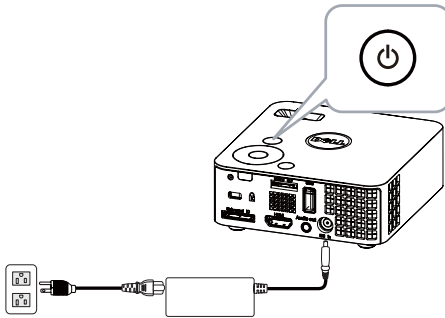

- 2 Plug in a **USB flash disk** to your projector.

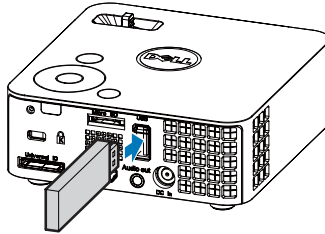

- 3 Access the **Input Source** menu, select the **USB** option, and press the  button.

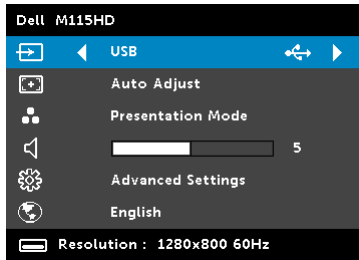

The **USB Screen** shown below appears:

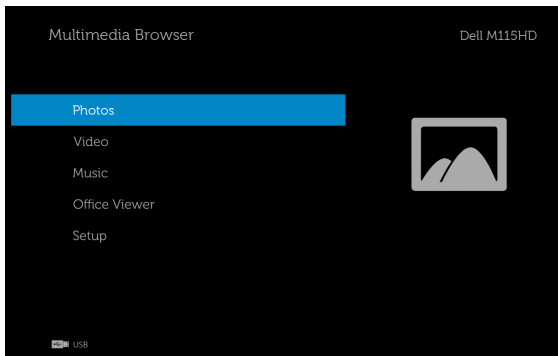

- 4 Select the multimedia files: **Photo**, **Video**, **Music**, or **Office Viewer**, and then press the  to start playing. Or select the **Setup** option to change multimedia settings. See "Multimedia Setup" on page 47.

How to set-up File Type for Multimedia with Micro SD Card

 **NOTE:** A micro SD card must be plugged into the projector if you want to use the multimedia micro SD function.

Follow these steps to playback the Photo, Video, or Music files on your projector:

- 1 Connect the power cable with AC adapter and turn on the projector by pressing the power button.

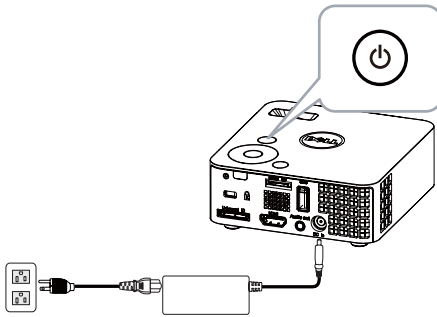

- 2 Plug in a **Micro SD card** to your projector. The image input source will be automatically switched to micro SD screen when you plug in a micro SD card.

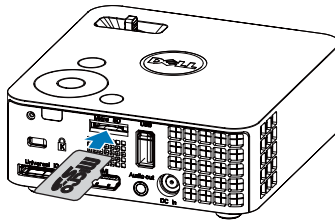

- 3 Access the **Input Source** menu, select the **Micro SD** option and press the  button.

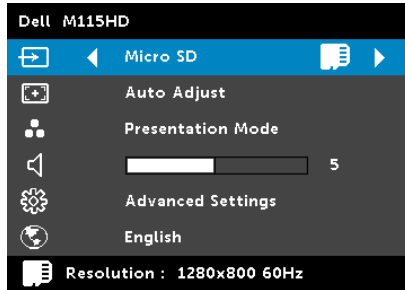

The **Micro SD Screen** shown below appears:

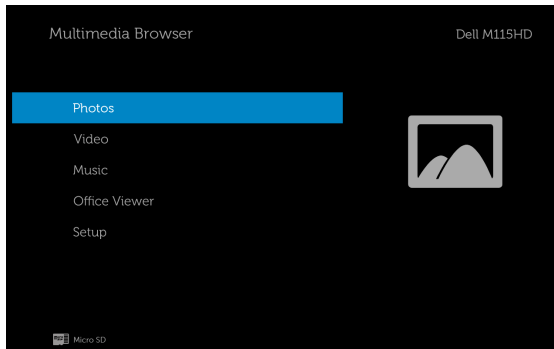

- 4 Select the multimedia files: **Photo**, **Video**, **Music**, or **Office Viewer**, and then press the  to start playing. Or select the **Setup** option to change multimedia settings. See "Multimedia Setup" on page 47.

How to set-up File Type for Multimedia with Internal Memory

Follow these steps to playback the Photo, Video, or Music files on your projector:

- 1 Connect the power cable with AC adapter and turn on the projector by pressing the power button.

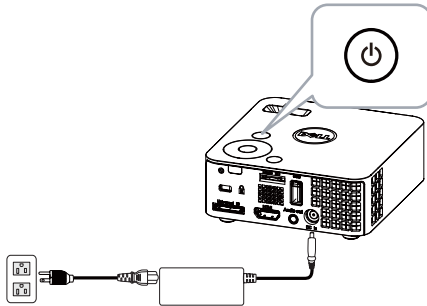

- 2 Access the **Input Source** menu, select the **Internal Memory** option and press the button.

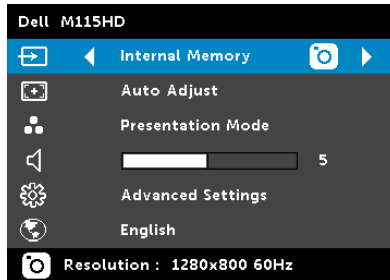

The **Internal Memory Screen** shown below appears:

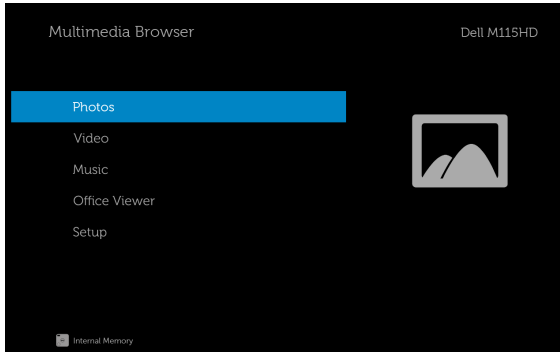

- 3 Select the multimedia files: **Photo, Video, Music, or Office Viewer**, and then press the  to start playing. Or select the **Setup** option to change multimedia settings. See "Multimedia Setup" on page 47.





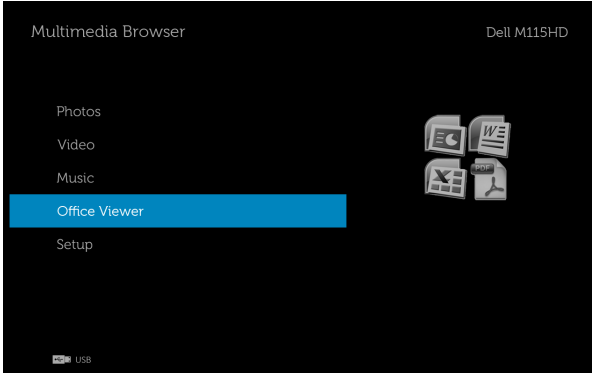

Office Viewer for the USB, SD, and Internal Memory

The Office Viewer feature allows you to use MS Excel, MS Word, MS PowerPoint, and PDF files.



Buttons Introduction

Use the up, down, left, and right buttons for navigation and  button on your projector's control panel or remote control to select.

Button	Up 	Down 	Left 	Right 	Enter 	Menu 
No sub-menu	Up	Down	Left	Right	Fit Page / Fit Width	Operating Menu
Pop up sub- menu	Page Up	Page Down	Zoom In	Zoom Out	Rotate	Quit Office Viewer

Multimedia SETUP for USB, Micro SD, and Internal Memory

The multimedia setup menu allows you to change settings for Photo, Video, and Music.



NOTE: Multimedia setup menu and settings are the same for the USB, Micro SD, and Internal Memory.

PHOTO SETUP

Select and press to activate photo setup menu. The photo setup menu provides the following options:

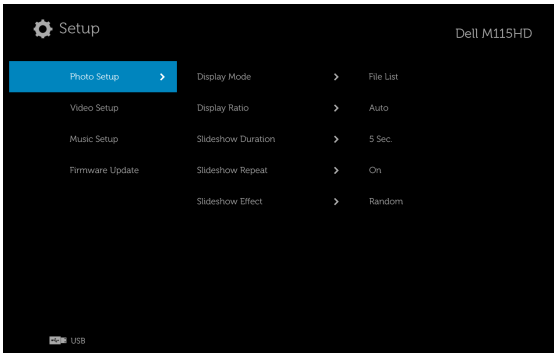

DISPLAY MODE—Press or to select the display mode of the photo on the screen. Options are: **File List**, **Thumbnail**, and **Slideshow**.

DISPLAY RATIO—Press or to select the display ratio of the photo as **Auto** (original ratio) or **Full** (full screen).

SLIDESHOW DURATION—Press or to select the slideshow duration. The image will automatically switch to the next photo after the time out. Options are: **5 sec**, **15 sec**, **30 sec**, **1 min**, **5 min**, and **15 min**.

SLIDESHOW REPEAT—Select **On** to repeat slideshow always. Or select "**Off**" to stop slideshow when it goes to the last page.

SLIDESHOW EFFECT—Press or to select what slideshow effect you want. Options are: **Random**, **Rect**, **Off**, **Snake**, **Partition**, **Erase**, **Blinds**, **Lines**, **GridCross**, **Cross**, and **Spiral**.





NOTE: Slideshow Duration, Slideshow Repeat, and Slideshow Effect function only supports Slideshow mode.

VIDEO SETUP

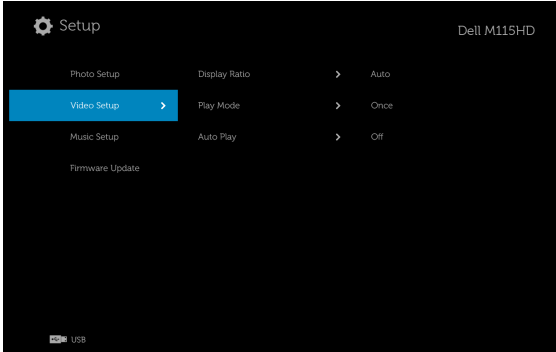

Select and press  to activate video setup menu. The video setup menu provides the following options:



DISPLAY RATIO—Press  or  to select the display ratio of the Video.

AUTO—Keep original aspect ratio.

ORIGINAL SIZE—Display video in original size of the content.

PLAY MODE—Press  or  to select the video play mode. Options are: **Once**, **Repeat Once**, **Repeat**, and **Random**.

AUTO PLAY—Select **On** to play the video automatically while entering the video list.

MUSIC SETUP

Select and press  to activate music setup menu. The music setup menu provides the following options:

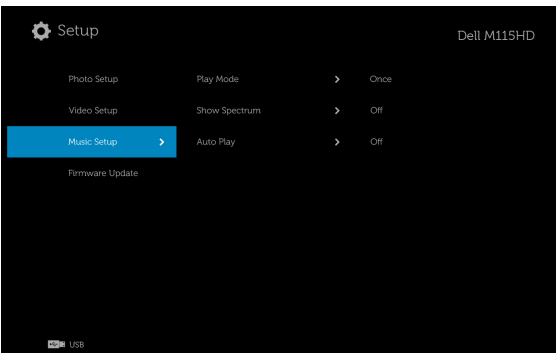

PLAY MODE—Press \uparrow or \downarrow to select the music play mode. Options are: **Once**, **Repeat Once**, **Repeat**, and **Random**.

SHOW SPECTRUM—Select **On** to show the spectrum plot while music is playing.

AUTO PLAY—Select **On** to play the music automatically while entering the music list.

FIRMWARE UPDATE

Select and press \checkmark to activate firmware update menu. The firmware update menu provides the following options:

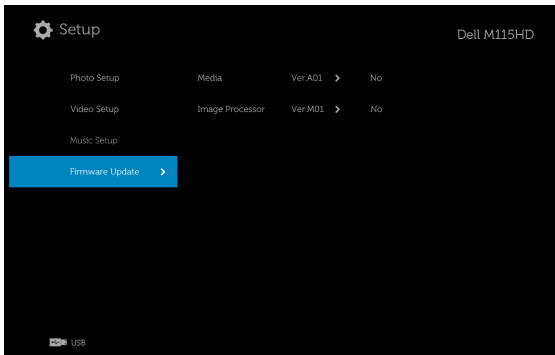

MEDIA—Select "Yes" to enter firmware update screen, and then select Confirm option to update your media firmware by micro SD card and USB flash drive.

IMAGE PROCESSOR—Select "Yes" to enter firmware update screen, and then select Confirm option to update your Video decoder firmware by micro SD card and USB flash drive.

 **NOTE:** Media and Image Processor firmware upgrade supports micro SD interface and USB flash drive. Please ensure the **Media** and **Image Processor** firmware (*.bin and *.inf files) are in the root directory of Micro SD card (or USB flash drive).

 **NOTE:** You can download the "media and image processor" firmware files from the Dell Support site at dell.com/support.

4

Troubleshooting Your Projector



If you experience problems with your projector, see the following troubleshooting tips. If the problem persists, contact Dell (see Contacting Dell on page 58).



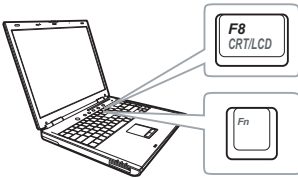

Problem

No image appears on the screen



Possible Solution

- Ensure that the projector is turned on.
 - Ensure that you have chosen the correct input source on the INPUT SOURCE menu.
 - Ensure the external graphics port is enabled. If you are using a Dell laptop computer, press   (Fn+F8). For other computers, see your respective documentation. If images are not displayed properly, please upgrade the video driver of your computer. For Dell computers, see dell.com/support.
 - Ensure that all the cables are securely connected. See "Connecting Your Projector" on page 7.
 - Ensure that the pins of the connectors are not bent or broken.
 - Use **Test Pattern** in the **Projector Settings** of the **Advanced Settings** menu. Ensure that the colors of the test pattern are correct.
-

Problem (continued)	Possible Solution (continued)
Partial, scrolling, or incorrectly displayed image	<ol style="list-style-type: none"> 1 Press the Auto Adjust button on the remote control or the control panel. 2 If you are using a Dell portable computer, set the resolution of the computer to WXGA (1280 x 800): <ol style="list-style-type: none"> a Right-click the unused portion of your Microsoft® Windows® desktop, click Properties, and then select Settings tab. b Verify that the setting is 1280 x 800 pixels for the external monitor port. c Press   (Fn+F8). <p>If you experience difficulty in changing resolutions, or if your monitor freezes, restart all the equipment and the projector.</p> <p>If you are not using a Dell portable computer, see your documentation. If images are not displayed properly, please upgrade the video driver of your computer. For a Dell computer, see dell.com/support.</p>
The screen does not display your presentation	If you are using a portable computer, press   (Fn+F8).
Image is unstable or flickering	Adjust the tracking in the OSD Display Settings of the Advanced Settings menu (in PC Mode only).
Image has vertical flickering bar	Adjust the frequency in the OSD Display Settings of the Advanced Settings menu (in PC Mode only).
Image color is incorrect	Use Test Pattern in the Projector Settings of the Advanced Settings menu. Ensure that the colors of the test pattern are correct.
Image is out of focus	<ol style="list-style-type: none"> 1 Adjust the focus ring on the projector lens. 2 Ensure that the projection screen is within the required distance from the projector (3.18 ft [97 cm] to 8.48 ft [258 cm]).

Problem (continued)	Possible Solution (continued)
Image is reversed	Select Projector Settings of the Advanced Settings from the OSD and adjust the projector mode.
Error LED is blinking amber	A projector fan has failed and the projector will automatically shut down.
TEMP LED is solid amber	The projector has overheated. The display automatically shuts down. Turn the display on again after the projector cools down. If the problem persists, contact Dell.
TEMP LED is blinking amber	If the projector fan fails, the projector will automatically shut down. Clear the projector mode by pressing and holding the POWER button for 10 seconds. Please wait for about 5 minutes and try to power up again. If the problem persists, contact Dell.
The OSD does not appear on the screen	Press the Menu button on the panel for 15 seconds to unlock the OSD. Check the Menu Lock on page 34.
The remote control is not operating smoothly or works only within a limited range	The battery may be low. Check if the LED indication from the remote is too dim. If so, replace with a new CR2032 battery.
DoUSB not displaying	Display over USB Should run automatically. To manually run USB display, go to My Computer and run "USB_Display.exe".  NOTE: You may require administrator level access to install the driver. Contact your network administrator for support.

Guiding Signals

Projector Status	Description	Control Buttons		Indicator	
		Power (White/Amber)	TEMP (Amber)	 (Amber)	
Standby mode	Projector in Standby mode. Ready to power on.	White Flashing	OFF	OFF	OFF
LED on	Projector in Normal mode, ready to display an image.	White	OFF	OFF	OFF
Cooling mode	Projector is cooling to shutdown.	White	OFF	OFF	OFF
Projector overheated	Air vents might be blocked or ambient temperature may be above 35 °C. The projector automatically shuts down. Ensure that the air vents are not blocked and that the ambient temperature is within operational range. If the problem persists, contact Dell.	OFF	AMBER	OFF	OFF
Fan breakdown	One of the fans has failed. The projector automatically shuts down. If the problem persists, contact Dell.	OFF	AMBER Flashing	OFF	OFF
LED failure	LED defective.	OFF	OFF	AMBER	AMBER
R-LED driver over-heated	Air vents might be blocked or the R-LED driver has overheated. The projector will automatically shut down. Turn the display on again after the projector cools down. If the problem persists, contact Dell.	AMBER	AMBER	OFF	OFF

5

Specifications

Light Valve	0.45" WXGA S450 DMD, DarkChip3™
Brightness	450 ANSI Lumens (Max.)
Contrast Ratio	10000:1 Typical (Full On/Full Off)
Uniformity	80% Typical (Japan Standard - JBMA)
Number of Pixels	1280 x 800 (WXGA)
Aspect Ratio	16:10
Internal Flash	1 GB Memory (Max.)
Displayable Color	1.07 billion colors
Projection Lens	F-Stop: F/2.0 f=14.95 mm Fixed Lens Throw ratio =1.5 wide and tele Offset ratio: 100%
Projection Screen Size	30~80 inches (diagonal)
Projection Distance	3.18~8.48 ft (97~258 cm)
Video Compatibility	HDMI input: 1080p, 720p, 576i/p, 480i/p
Power Supply	Universal AC 100-240 V 50-60 Hz with 65 W power adapter
Power Consumption	Normal mode: 52 W \pm 10% @ 110 Vac Eco mode: 42 W \pm 10% @ 110 Vac Power saving mode: < 0.5 W (Fan speed at minimum) Standby mode: < 0.5 W
Audio	1 speaker x 1 watt RMS
Noise Level	Normal mode: 36 dB(A) Typical Eco mode: 32 dB(A) Typical
Weight	0.8 lbs \pm 0.05 lbs (0.36 kg \pm 0.02 kg)

Dimensions (W x H x D) 4.14 x 1.43 x 4.09 inches (105.3 x 36.5 x 104 mm)

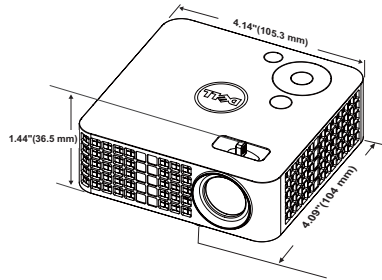

Environmental	Operating temperature: 5 °C - 35 °C (41 °F- 95 °F) Humidity: 80% maximum Storage temperature: 0 °C to 60 °C (32 °F to 140 °F) Humidity: 90% maximum Shipping temperature: -20 °C to 60 °C (-4 °F to 140 °F) Humidity: 90% maximum
I/O Connectors	Power: One DC power jack
	VGA input: One 24-pin universal connector (Black) for analog RGB input signal and supporting Audio output.
	HDMI input: One HDMI connector for supporting HDMI 1.3. HDCP compliant.
	Audio output: One 3.5 mm stereo mini phone jack.
	USB (type A) port: One USB connector for supporting USB display, multimedia playback (Video/Music/Photo/Office Viewer), USB memory storage access (USB flash drive/internal memory), and supporting projector, media, and image processor firmware upgrade, and supporting optional wireless dongle, MobiShow-Pro, and WiFi-Doc. The USB thumb drive can support up to 32 GB.

	<p>Micro SD card slot: One micro SD connector for supporting multimedia playback (Video/Music/Photo/Office Viewer) and supporting media and image processor firmware upgrade</p> <p>The micro SD card can support up to 32 GB.</p>
Wireless Dongle (Optional)	<p>Wireless Standard: IEEE 802.11b/g/n</p> <p>Wireless: One USB (type A) connector for supporting wireless dongle (USB interface, optional) and mobishow.</p> <p>OS environment: Windows 8/7/Vista/XP/2000, MAC OS X</p> <p>Supports MobiShow and WiFi-Doc projection.</p>
Light Source	Mercury-free LED (up to 30000 hours in Normal mode)



NOTE: The LED life rating for any projector is a measure of brightness degradation only, and is not a specification for the time it takes a LED to fail and cease light output. LED life is defined as the time it takes for more than 50 percent of a LED sample population to have brightness decrease by approximately 50 percent of the rated lumens for the specified LED. The LED life rating is not guaranteed in any way. The actual operating life span of a projector LED will vary according to operating conditions and usage patterns. Usage of a projector in stressful conditions which may include dusty environments, under high temperatures, many hours per day, and abrupt powering-off will most likely result in a LED's shortened operating life span or possible LED failure.

Compatibility Modes (Digital)

Resolution	Refresh Rate (Hz)	Hsync Frequency (KHz)	Pixel Clock (MHz)
640 x 350	70.087	31.469	25.175
640 x 480	59.940	31.469	25.175
720 x 480 p60	59.940	31.469	27.000
720 x 576 p50	50.000	31.250	27.000
720 x 400	70.087	31.469	28.322
640 x 480	75.000	37.500	31.500
640 x 480	85.008	43.269	36.000
800 x 600	60.317	37.879	40.000
800 x 600	75.000	46.875	49.500
800 x 600	85.061	53.674	56.250
1024 x 768	60.004	48.363	65.000
1280 x 720 p50	50.000	37.500	74.250
1280 x 720 p60	60.000	45.000	74.250
1920 x 1080 i50	50.000	28.125	74.250
1920 x 1080 i60	60.000	33.750	74.250
1280 x 720	59.855	44.772	74.500
1024 x 768	75.029	60.023	78.750
1280 x 800	59.810	49.702	83.500
1366 x 768	59.790	47.712	85.500
1360 x 768	60.015	47.712	85.500
1024 x 768	84.997	68.677	94.500
1440 x 900	59.887	55.935	106.500
1280 x 1024	60.020	63.981	108.000
1400 x 1050	59.978	65.317	121.750
1280 x 800	84.880	71.554	122.500
1280 x 1024	75.025	79.976	135.000
1440 x 900	74.984	70.635	136.750
1680 x 1050	59.954	65.290	146.250
1280 x 960	85.002	85.938	148.500
1920 x 1080	60.000	67.500	148.500

6

Contacting Dell

For customers in the United States, call 800-WWW-DELL (800-999-3355).



NOTE: If you do not have an active Internet connection, you can find contact information on your purchase invoice, packing slip, bill, or Dell product catalog.

Dell™ provides several online and telephone-based support and service options. Availability varies by country and product, and some services may not be available in your area. To contact Dell for sales, technical support, or customer service issues:

- 1 Visit go to www.dell.com/contactDell.
- 2 Select your region on the interactive map.
- 3 Select a Segment for Contact.
- 4 Select the appropriate service or support link based on your need.

7

Appendix: Glossary

ANSI Lumens — A standard for measuring the brightness. It is calculated by dividing a square meter image into nine equal rectangles, measuring the lux (or brightness) reading at the center of each rectangle, and averaging these nine points.

Aspect Ratio — The most popular aspect ratio is 4:3 (4 by 3). Early television and computer video formats are in a 4:3 aspect ratio, which means that the width of the image is 4/3 times the height.

Brightness — The amount of light emitted from a display or projection display or projection device. The brightness of projector is measured by ANSI lumens.

Color Temperature — The color appearance of white light. Low color temperature implies warmer (more yellow/red) light while high color temperature implies a colder (more blue) light. The standard unit for color temperature is Kelvin (K).

Compressed Resolution — If the input images are of higher resolution than the native resolution of the projector, the resulting image will be scaled to fit the native resolution of the projector. The nature of compression in a digital device means that some image content is lost.

Contrast Ratio — Range of light and dark values in a picture, or the ratio between their maximum and minimum values. There are two methods used by the projection industry to measure the ratio:

- 1 Full On/Off** — measures the ratio of the light output of an all white image (full on) and the light output of an all black (full off) image.
- 2 ANSI** — measures a pattern of 16 alternating black and white rectangles. The average light output from the white rectangles is divided by the average light output of the black rectangles to determine the ANSI contrast ratio.

Full On/Off contrast is always a larger number than ANSI contrast for the same projector.

dB — decibel — A unit used to express relative difference in power or intensity, usually between two acoustic or electric signals, equal to ten times the common logarithm of the ratio of the two levels.

Diagonal Screen — A method of measuring the size of a screen or a projected image. It measures from one corner to the opposite corner. A 9

FT high, 12 FT wide, screen has a diagonal of 15 FT. This document assumes that the diagonal dimensions are for the traditional 4:3 ratio of a computer image as per the example above.

DLP® — Digital Light Processing™ — Reflective display technology developed by Texas Instruments, using small manipulated mirrors. Light passing through a color filter is sent to the DLP mirrors which arrange the RGB colors into a picture projected onto screen, also known as DMD.

DMD — Digital Micro-Mirror Device — Each DMD consists of thousands of tilting, microscopic aluminum alloy mirrors mounted on a hidden yoke.

Focal Length — The distance from the surface of a lens to its focal point.

Frequency — It is the rate of repetition in cycles per seconds of electrical signals. Measured in Hz (Hertz).

HDCP — High-Bandwidth Digital-Content Protection — A specification developed by Intel™ Corporation to protect digital entertainment across digital interface, such as DVI, HDMI.

HDMI — High-Definition Multimedia Interface — HDMI carries both uncompressed high definition video along with digital audio and device control data in a single connector.

Hz (Hertz) — Unit of frequency.

Keystone Correction — Device that will correct an image of the distortion (usually a wide-top narrow-bottom effect) of a projected image caused by improper projector to screen angle.

Maximum Distance — The distance from a screen the projector can be to cast an image that is usable (bright enough) in a fully darkened room.

Maximum Image Size — The largest image a projector can throw in a darkened room. This is usually limited by focal range of the optics.

Minimum Distance — The closest position that a projector can focus an image onto a screen.

NTSC — National Television Standards Committee. North American standard for video and broadcasting, with a video format of 525 lines at 30 frames per second.

PAL — Phase Alternating Line. A European broadcast standard for video and broadcasting, with a video format of 625 lines at 25 frames per second.

Reverse Image — Feature that allows you to flip the image horizontally. When used in a normal forward projection environment text, graphics, etc. are backwards. Reverse image is used for rear projection.

SVGA — Super Video Graphics Array — 800 x 600 pixels count.

SXGA — Super Extended Graphics Array, — 1280 x 1024 pixels count.

UXGA — Ultra Extended Graphics Array — 1600 x 1200 pixels count.

VGA — Video Graphics Array — 640 x 480 pixels count.

XGA — Extended Video Graphics Array — 1024 x 768 pixels count.

WXGA — Wide Extended Graphics Array — 1280 x 800 pixels count.

Zoom Lens — Lens with a variable focal length that allows the operator to move the view in or out making the image smaller or larger.

Zoom Lens Ratio — Is the ratio between the smallest and largest image a lens can project from a fixed distance. For example, a 1.4:1 zoom lens ratio means that a 10 foot image without zoom would be a 14 foot image with full zoom.

Index

A

- Adjusting the Projected Image 16
 - Adjusting the Projector Height 16
 - lower the projector
 - Front tilt adjustment wheel 16
- Adjusting the Projector Zoom and Focus 17
 - Focus ring 17

C

- Connecting the Projector
 - AC adaptor 8, 9, 12, 13, 14
 - Connecting with an HDMI Cable 12
 - HDMI cable 12
 - Power cord 8, 9, 12, 13, 14
 - To Computer 8
 - Universal 24-pin to VGA cable 8
 - USB-A to USB-A cable 9
- Connection Ports
 - Audio output connector 7
 - DC input connector 7
 - HDMI connector 7
 - Security cable slot 7
- Contact Dell 4, 52
- Control Panel 20

D

- Dell
 - contacting 58, 59

M

- Main Unit 5
 - Control panel 5
 - Elevator button for height adjustments 5
 - Focus ring 5
 - Lens 5
- Menu Position 34
- Menu Settings 33
- Menu Timeout 34
- Menu Transparency 34

O

- On-Screen Display 26
 - Input Source 26

P

- Password 34
- phone numbers 58
- Power Saving 37
- Power Settings 37
- Powering On/Off the Projector

Powering Off the Projector 15
Powering On the Projector 15

R

Remote Control 22
Reset, Factory 33

S

Specifications
 Aspect Ratio 54
 Audio 54
 Brightness 54
 Contrast Ratio 54
 Dimensions 55
 Displayable Color 54
 Environmental 55
 I/O Connectors 55
 Internal Flash 54
 Light Valve 54
 Noise Level 54
 Number of Pixels 54
 Power Consumption 54
 Power Supply 54
 Projection Distance 54
 Projection Lens 54
 Projection Screen Size 54
 Uniformity 54
 Video Compatibility 54
 Weight 54
support
 contacting Dell 58, 59

T

telephone numbers 58
Test Pattern 32
Troubleshooting 50
 Contact Dell 50